

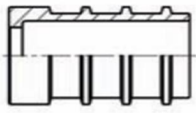







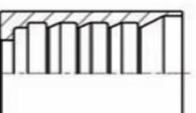
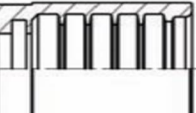

套筒 FERRULE

<p>R7树脂管套筒 Ferrele For Two Polyester Braid Hose</p>	 S00018	<p>国标、部标两层钢丝剥外胶套筒 Ferrule For China 2 Steel Wire Hose</p>	 S01200
<p>一层钢丝剥外胶套筒 Ferrele For GB 3863 1TYPE, DIN 200221ST,SAE 100R1A Hose</p>	 S00100	<p>国标、部标三层钢丝剥外胶套筒 Ferrule For China 3 Steel Wire Hose</p>	 S01300
<p>两层钢丝剥外胶套筒 Ferrele For GB3863 2 TYPE, DIN 20022 2ST,SAE 100R2A Hose</p>	 S00200	<p>国标、部标四层钢丝剥外胶套筒 Ferrule For SAE 100R12/20-24, GB 10544 5Type Hose</p>	 S01400
<p>一层钢丝不剥胶套筒 Ferrule For SAE 100R1AT, DIN20022 1SN Hose</p>	 S00110-A	<p>四层钢丝剥外胶套筒 Ferrele For GB 10544 3Type/20-32, SAE 100R12/06-16,DIN 20023-4SP, 4SH/10-16 Hose</p>	 S00400
<p>一层钢丝不剥胶套筒 Ferrule For SAE 100R1AT, DIN20022 1SN Hose</p>	 S00110	<p>四层钢丝剥外胶套筒 Ferrele For DIN 20023-4SH20-32Hose</p>	 S00401
<p>两层钢丝不剥胶套筒 Ferrele For GB 3863 2 TYPE, DIN 20022 2SN ,SAE 100R2AT Hose</p>	 S00210	<p>多层钢丝剥内外胶套筒 Interlock Ferrule For SAE 100R13/R15, 4SH/12-16Hose</p>	 S00621
<p>两层钢丝不剥胶套筒 Ferrule For SAE R2AT, DIN 20022 2SN HOSE</p>	 S03310		
<p>国标、部标一层钢丝剥外胶套筒 Ferrule For China 1 Steel Wire Hose</p>	 S01100		

套筒 FERRULE

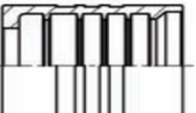
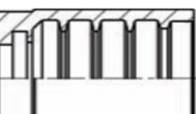
S00018

SAE 100 R7/R8软管套筒
FERRULE FOR SAE1000R7/R8 HOSE

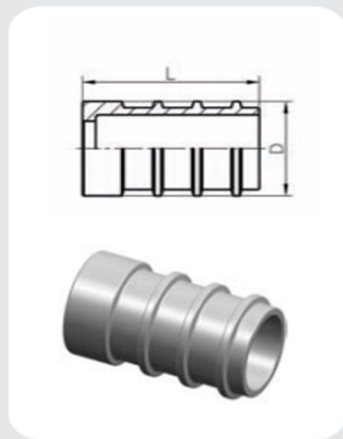

代号 PART NO.	软管 HOSE BORE		尺寸 DIMENSIONS	
	公称内径 DN	标号 DASH	L	D
S00018-02	4	02	25	13.5
S00018-03	5	03	27	15
S00018-04	6	04	30	18
S00018-04A	6	04	29	14
S00018-05	8	05	30	18.8
S00018-06	10	06	34	21
S00018-08	13	08	34	25.5
S00018-08A	13	08	34	27.2
S00018-10	16	10	37	31.5
S00018-10A	16	10	37	28.6
S00018-12	19	12	43	33

S00100

GB 3863 1型、DIN 20022 1ST、SAE 100R1A软管套筒
For GB 3863 1 TYPE、DIN 20022 1ST、SAE 100R1A HOSE FERRULE

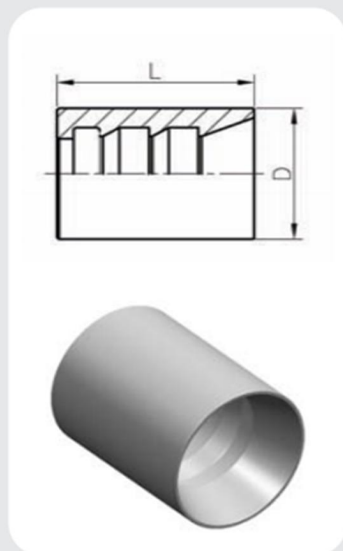

代号 PART NO.	软管 HOSE BORE		尺寸 DIMENSIONS	
	公称内径 DN	标号 DASH	L	D
S00100-04	6	04	30	20
S00100-05	8	05	31	21
S00100-06	10	06	32	23
S00100-08	13	08	34	28.5
S00100-10	16	10	37	32
S00100-12	19	12	42	35
S00100-16	25	16	50	43
S00100-20	32	20	59	50.5
S00100-24	38	24	72	57
S00100-32	51	32	74	70

套筒 FERRULE

S00200

GB 3863 2型、DIN 20022 2ST、SAE 100R2A软管套筒

For GB 3863 2 TYPE、DIN 20022 2ST、SAE 100R2A HOSE FERRULE

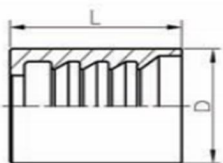

代号 PART NO.	软管 HOSE BORE		尺寸 DIMENSIONS	
	公称内径 DN	标号 DASH	L	D
S00200-04	6	04	30	21
S00200-05	8	05	31	22.5
S00200-06	10	06	32	24
S00200-08	13	08	34	28.7
S00200-10	16	10	37	31.5
S00200-12	19	12	43	36
S00200-16	25	16	50	44
S00200-20	32	20	59	54.5
S00200-24	38	24	74	62
S00200-32	51	32	78	75

S00110-A

改进型 SAE 100R1AT/DIN20022 1SN软管套筒

FERRULE FOR SAE 100R1AT/DIN20022 1SN HOSE

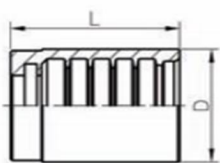

代号 PART NO.	软管 HOSE BORE		尺寸 DIMENSIONS	
	公称内径 DN	标号 DASH	L	D
S00110-04A	6	04	30	21
S00110-05A	8	05	31	21.8
S00110-06A	10	06	32	24.3
S00110-08A	13	08	34	28.4
S00110-10A	16	10	37	31
S00110-12A	19	12	43	35.5
S00110-16A	25	16	50	44
S00110-20A	32	20	59	53
S00110-24A	38	24	74	59.3
S00110-32A	51	32	77	73.5

S00110

SAE 100R1AT/DIN20022 1SN软管套筒

FERRULE FOR SAE 100R1AT/DIN20022 1SN HOSE

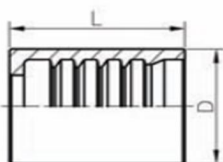

代号 PART NO.	软管 HOSE BORE		尺寸 DIMENSIONS	
	公称内径 DN	标号 DASH	L	D
S00110-04	6	04	30	20.6
S00110-05	8	05	31	20.8
S00110-06	10	06	32	23.3
S00110-08	13	08	34	27
S00110-10	16	10	37	30
S00110-12	19	12	43	34
S00110-16	25	16	50	42.6
S00110-20	32	20	59	52
S00110-24	38	24	74	58
S00110-32	51	32	78	72

套筒 FERRULE

S00210

GB 3863 2型、DIN 20022 2SN、SAE 100R2AT软管套筒

For GB 3863 2 TYPE、DIN 20022 2SN、SAE 100R2AT HOSE FERRULE



代号 PART NO.	软管 HOSE BORE		尺寸 DIMENSIONS	
	公称内径 DN	标号 DASH	D	L
S00210-04	6	04	22.3	30
S00210-05	8	05	23	31
S00210-06	10	06	25	32
S00210-08	13	08	28.7	34
S00210-10	16	10	31.5	37
S00210-12	19	12	35.5	43
S00210-16	25	16	45	50
S00210-20	32	20	55	59
S00210-24	38	24	62.5	74
S00210-32	51	32	75.5	78

注:不推荐用于工程机械类。 Don't recommend for engineering machineries

S03310

SAE 100R1AT/R2AT、DIN 20022 1SN/2SN软管套筒

FERRULE FOR SAE R1AT/R2AT、DIN 20022 2SN HOSE

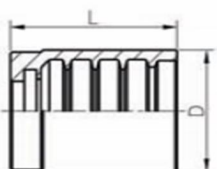

代号 PART NO.	软管 HOSE BORE		尺寸 DIMENSIONS	
	公称内径 DN	标号 DASH	D	L
S03310-04	6	04	23.2	30
S03310-05	8	05	24	30
S03310-06	10	06	26.3	32
S03310-08	13	08	29.9	34
S03310-10	16	10	33.2	36
S03310-12	19	12	37.8	42
S03310-16	25	16	46.9	50
S03310-20	32	20	59	59
S03310-24	38	24	67	72
S03310-32	51	32	80	75

套筒 FERRULE

S01100

国产一层钢丝编织软管套筒

FERRULE FOR CHINA STANDARD 1-STEEL WIRE BRAID HOSE

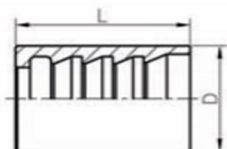

代号 PART NO.	软管 HOSE BORE		尺寸 DIMENSIONS	
	公称内径 DN	标号 DASH	L	D
S01100-04	6	04	30	19
S01100-05	8	05	32	21
S01100-06	10	06	32	23
S01100-08	13	08	34	28
S01100-10	16	10	37	31
S01100-12	19	12	43	34
S01100-16	25	16	50	41
S01100-20	32	20	59	49
S01100-24	38	24	74	55

S01200

国产两层钢丝编织软管套筒

FERRULE FOR CHINA STANDARD 2-STEEL WIRE BRAID HOSE

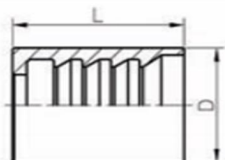

代号 PART NO.	软管 HOSE BORE		尺寸 DIMENSIONS	
	公称内径 DN	标号 DASH	L	D
S01200-04	6	04	30	21
S01200-05	8	05	31	23
S01200-06	10	06	32	25
S01200-08	13	08	34	31
S01200-10	16	10	39	34
S01200-12	19	12	43	37
S01200-16	25	16	50	43
S01200-20	32	20	59	51
S01200-24	38	24	74	57

S01300

国产三层钢丝编织软管套筒

FERRULE FOR CHINA STANDARD 3-STEEL WIRE BRAID HOSE

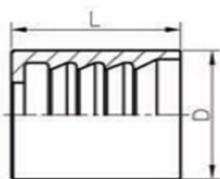

代号 PART NO.	软管 HOSE BORE		尺寸 DIMENSIONS	
	公称内径 DN	标号 DASH	L	D
S01300-05	8	05	32	25.5
S01300-08	13	08	34	33
S01300-10	16	10	39	36
S01300-12	19	12	43	39
S01300-16	25	16	50	45
S01300-20	32	20	59	53
S01300-24	38	24	74	59
S01300-32	51	32	78	72

套筒 FERRULE

S01400

SAE 100 R12/20-24, GB 10544 5型软管套筒

FERRULE FOR SAE 100 R12/20-24, GB 10544 5TYPE HOSE

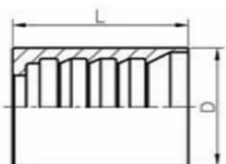

代号 PART NO.	软管 HOSE BORE		尺寸 DIMENSIONS	
	公称内径 DN	标号 DASH	L	D
S01400-06	10	06	39	27.5
S01400-08	13	08	41	31.5
S01400-10	16	10	43	34
S01400-12	19	12	51	39
S01400-16	25	16	61.5	46.5
S01400-20	32	20	67.5	55.5
S01400-24	38	24	75	63.5
S01400-32	51	32	79	78

S00400

SAE 100 R12/06-16, GB 10544 3型/20-32, DIN 20023-4SP, 4SH/10-16软管套筒

FERRULE For SAE 100 R12/06-16, GB 10544 3TYPE/20-32, DIN 20023-4SP, 4SH/10-16 HOSE

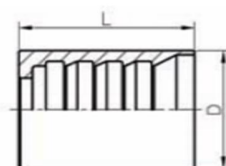

代号 PART NO.	软管 HOSE BORE		尺寸 DIMENSIONS	
	公称内径 DN	标号 DASH	L	D
S00400-04	6	04	37.5	22
S00400-06	10	06	39	25.5
S00400-08	13	08	41	29
S00400-10	16	10	43	34
S00400-12	19	12	51	37
S00400-16	25	16	61.5	46.5
S00400-20	32	20	67.5	57
S00400-24	38	24	75	65
S00400-32	51	32	79	79

S00401

DIN 20023-4SH 软管套筒

FERRULE FOR DIN 20023-4SH HOSE

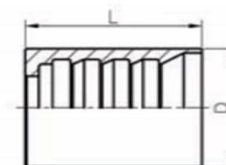

代号 PART NO.	软管 HOSE BORE		尺寸 DIMENSIONS	
	公称内径 DN	标号 DASH	L	D
S00401-20	32	20	67.5	53
S00401-24	38	24	75	61
S00401-32	51	32	79	77

套筒 FERRULE

S00621

SAE 100 R13/R15、4SH/12-16 软管剥内外胶套筒

INTERLOCK FERRULE FOR SAE 100R13/R15、4SH/12-16 HOSE

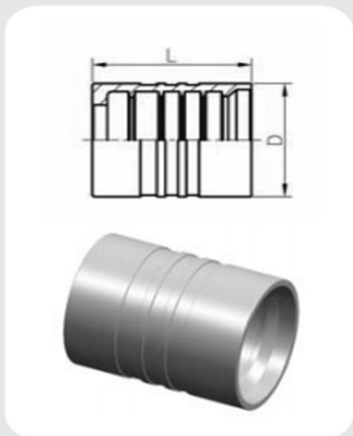

代号 PART NO.	软管 HOSE BORE		尺寸 DIMENSIONS	
	公称内径 DN	标号 DASH	L	D
S00621-12	19	12	53	39.5
S00621-16	25	15	66	48.5
S00621-20	32	20	88	59
S00621-24	38	24	102	69.3
S00621-32	51	32	106	84.45